

TABLE 8-2

Diameters and Area of Unified Screw Threads UNC and UNF*

SIZE DESIGNATION	NOMINAL MAJOR DIAMETER, in	COARSE SERIES—UNC			FINE SERIES—UNF		
		THREADS PER INCH <i>N</i>	TENSILE-STRESS AREA <i>A_t</i> , in ²	MINOR-DIAMETER AREA <i>A_s</i> , in ²	THREADS PER INCH <i>N</i>	TENSILE-STRESS AREA <i>A_t</i> , in ²	MINOR-DIAMETER AREA <i>A_s</i> , in ²
0	0.0600				80	0.001 80	0.001 51
1	0.0730	64	0.002 63	0.002 18	72	0.002 78	0.002 37
2	0.0860	56	0.003 70	0.003 10	64	0.003 94	0.003 39
3	0.0990	48	0.004 87	0.004 06	56	0.005 23	0.004 51
4	0.1120	40	0.006 04	0.004 96	48	0.006 61	0.005 66
5	0.1250	40	0.007 96	0.006 72	44	0.008 80	0.007 16
6	0.1380	32	0.009 09	0.007 45	40	0.010 15	0.008 74
8	0.1640	32	0.014 0	0.011 96	36	0.014 74	0.012 85
10	0.1900	24	0.017 5	0.014 50	32	0.020 0	0.017 5
12	0.2160	24	0.024 2	0.020 6	28	0.025 8	0.022 6
1/4	0.2500	20	0.031 8	0.026 9	28	0.036 4	0.032 6
3/8	0.3125	18	0.052 4	0.045 4	24	0.058 0	0.052 4
1/2	0.3750	16	0.077 5	0.067 8	24	0.087 8	0.080 9
5/8	0.4375	14	0.106 3	0.093 3	20	0.118 7	0.109 0
3/4	0.5000	13	0.141 9	0.125 7	20	0.159 9	0.148 6
7/8	0.5625	12	0.182	0.162	18	0.203	0.187
1	0.6250	11	0.226	0.202	18	0.256	0.240
1 1/8	0.7500	10	0.334	0.302	16	0.373	0.351
1 1/4	0.8750	9	0.462	0.419	14	0.509	0.481
1 1/2	1.0000	8	0.606	0.551	12	0.663	0.625
1 3/4	1.2500	7	0.969	0.890	12	1.073	1.024
2	1.5000	6	1.405	1.294	12	1.581	1.521

*This table was compiled from ANSI B1.1-1974. The minor diameter was found from the equation $d_s = d - 1.299\ 038p$, and the pitch diameter from $d_p = d - 0.649\ 519p$. The mean of the pitch diameter and the minor diameter was used to compute the tensile-stress area.

TABLE 8-3

Preferred Pitches for Acme Threads

<i>d</i> , in	1/4	3/8	1/2	5/8	3/4	1	1 1/4	1 1/2	1 3/4	2	2 1/2	3
<i>p</i> , in	1/16	1/16	1/16	1/16	1/16	1/16	1/16	1/16	1/16	1/16	1/16	1/16

TABLE 8-6

Metric Mechanical-Property Classes for Steel Bolts, Screws, and Studs*

PROPERTY CLASS	SIZE RANGE, INCLUSIVE	MINIMUM PROOF STRENGTH, MPa	MINIMUM TENSILE STRENGTH, MPa	MINIMUM YIELD STRENGTH, MPa	MATERIAL	HEAD MARKING
4.6	M5-M36	225	400	240	Low or medium carbon	
4.8	M1.6-M16	310	420	340	Low or medium carbon	
5.8	M5-M24	380	520	420	Low or medium carbon	
8.8	M1.6-M36	600	830	660	Medium carbon, Q&T	
9.8	M1.6-M16	650	900	720	Medium carbon, Q&T	
10.9	M5-M36	830	1040	940	Low-carbon martensite, Q&T	
12.9	M1.6-M36	970	1220	1100	Alloy, Q&T	

TABLE 8-4

SAE Specifications for Steel Bolts

















SAE GRADE NO.	SIZE RANGE, INCLUSIVE, in	MINIMUM PROOF STRENGTH, kpsi	MINIMUM TENSILE STRENGTH, kpsi	MINIMUM YIELD STRENGTH, kpsi	MATERIAL	HEAD MARKING
1	1-1 1/4	33	60	36	Low or medium carbon	
2	1-1 1-1 1/4	55 33	74 60	57 36	Low or medium carbon	
4	1-1 1/2	65	115	100	Medium carbon, cold-drawn	
5	1-1 1 1/2-1 1/4	85 74	120 105	92 81	Medium carbon, Q&T	
5.2	1-1	85	120	92	Low-carbon martensite, Q&T	
7	1-1 1/4	105	133	115	Medium-carbon alloy, Q&T	
8	1-1 1/4	120	150	130	Medium-carbon alloy, Q&T	
8.2	1-1	120	150	130	Low-carbon martensite, Q&T	

TABLE 8-5

ASTM Specifications for Steel Bolts

ASTM DESIGNATION NO.	SIZE RANGE, INCLUSIVE, in	MINIMUM PROOF STRENGTH, kpsi	MINIMUM TENSILE STRENGTH, kpsi	MINIMUM YIELD STRENGTH, kpsi	MATERIAL	HEAD MARKING
A307	1-1 1/4	33	60	36	Low carbon	
A325, type 1	1-1 1 1/4-1 1/2	85 74	120 105	92 81	Medium carbon, Q&T	
A325, type 2	1-1 1 1/4-1 1/2	85 74	120 105	92 81	Low-carbon martensite, Q&T	
A325, type 3	1-1 1 1/4-1 1/2	85 74	120 105	92 81	Weathering steel, Q&T	
A354, grade BC					Alloy-steel, Q&T	
A354, grade BD	1-4	120	150	130	Alloy steel, Q&T	
A449	1-1 1 1/4-1 1/2 1 1/2-3	85 74 55	120 105 90	92 81 58	Medium-carbon, Q&T	
A490, type 1	1-1 1/4	120	150	130	Alloy steel, Q&T	
A490, type 3					Weathering steel, Q&T	

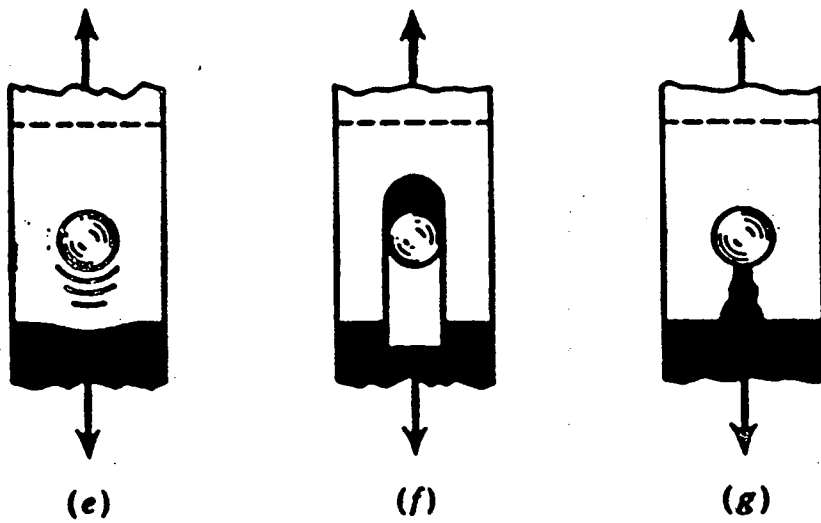
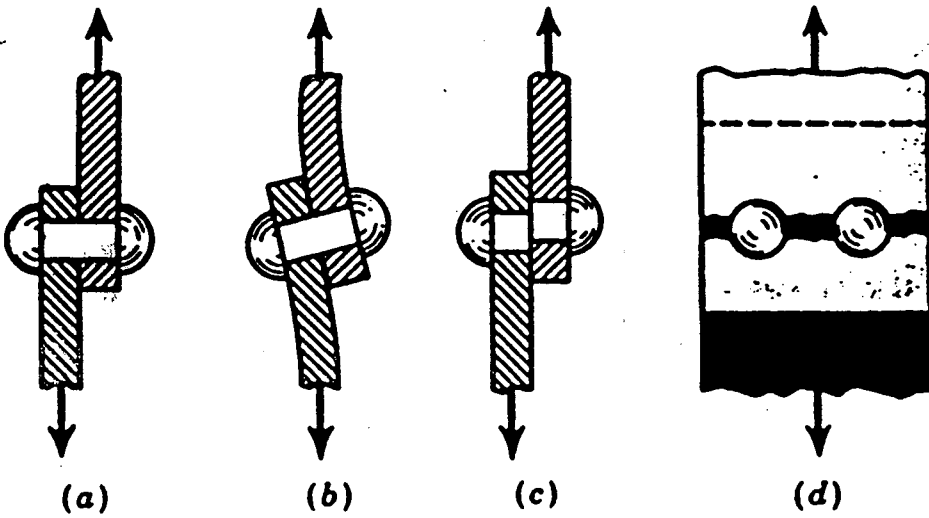
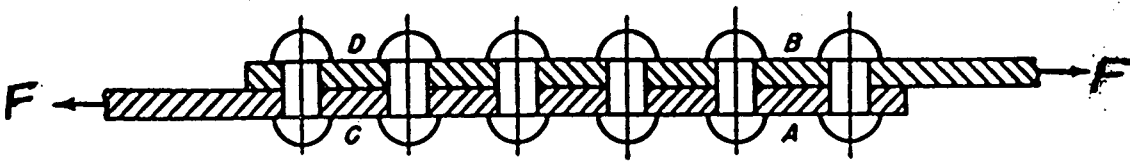

Fig 11.4

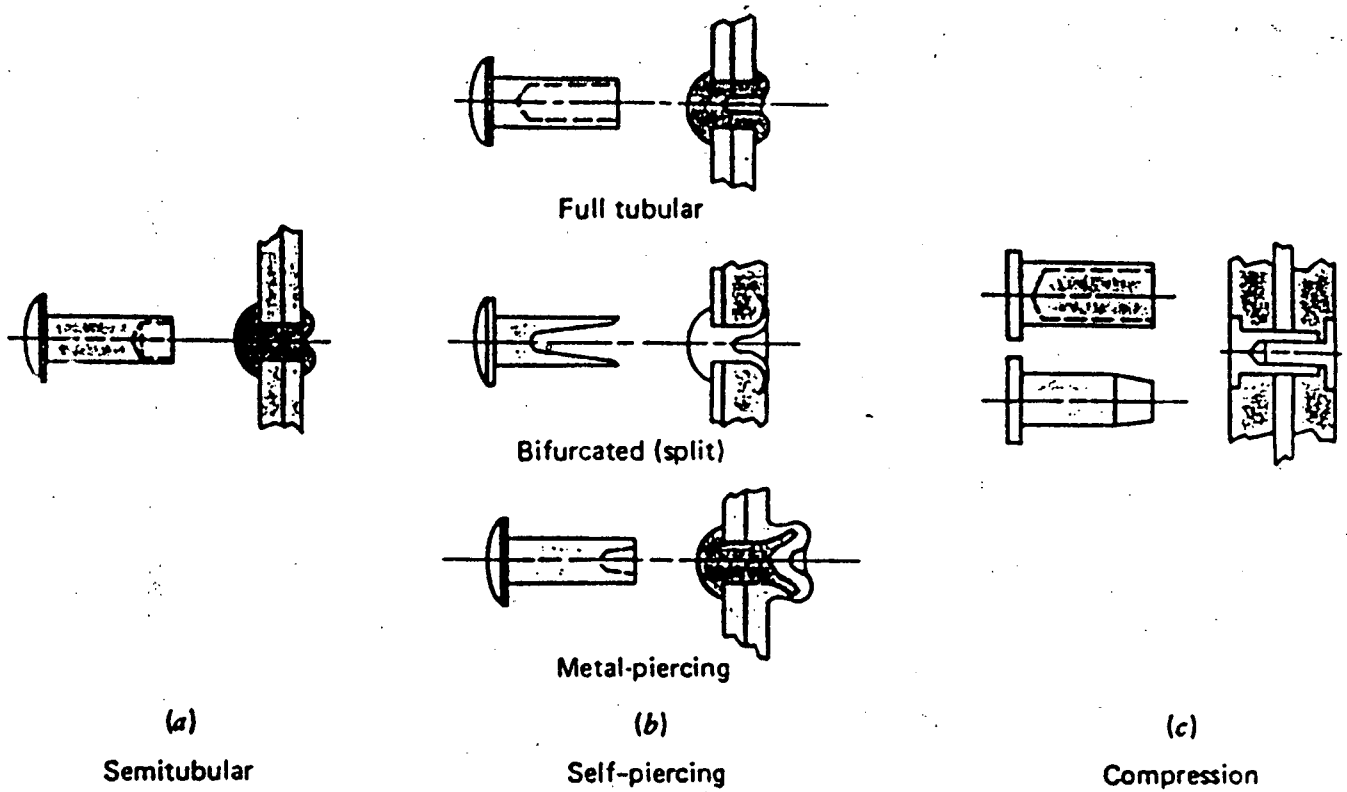
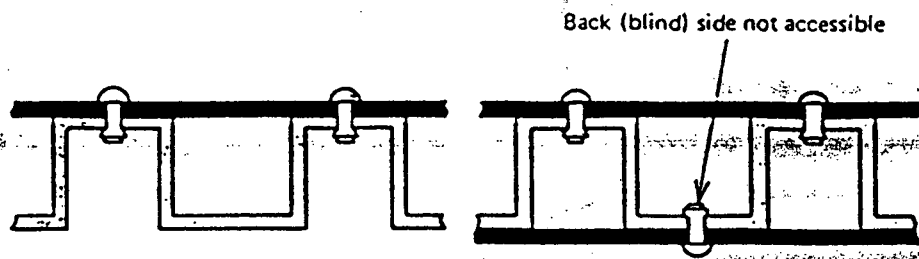
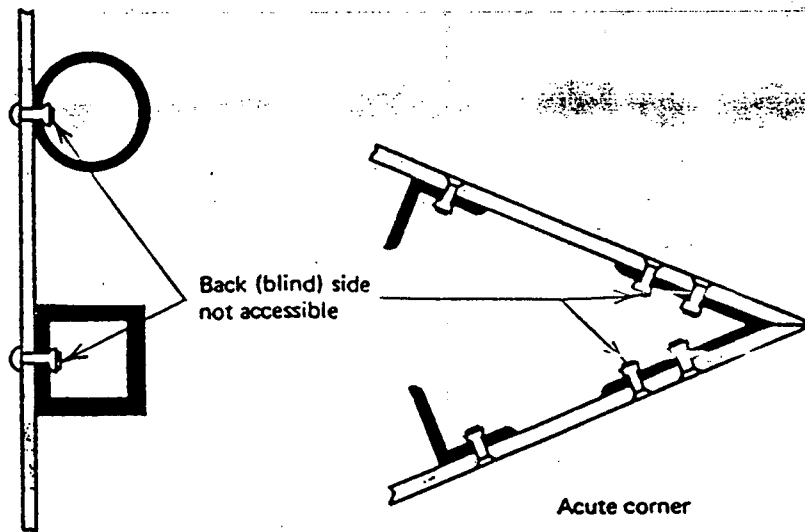

Figure 11.2 Basic types of tubular rivets [7]. (a) Semitubular. (b) Self-piercing. (c) Compression.



"Built-up" lightweight structure



Tube and pipe mount

Figure 11.3 Typical applications in which blind rivets are used [7].

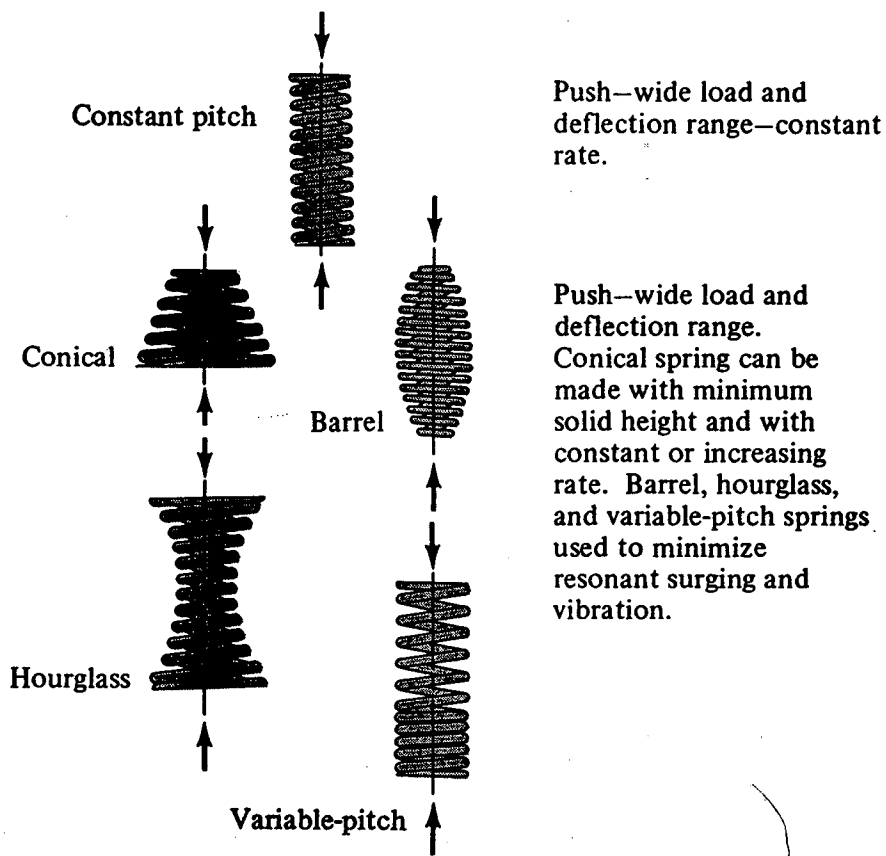

(a) Helical compression

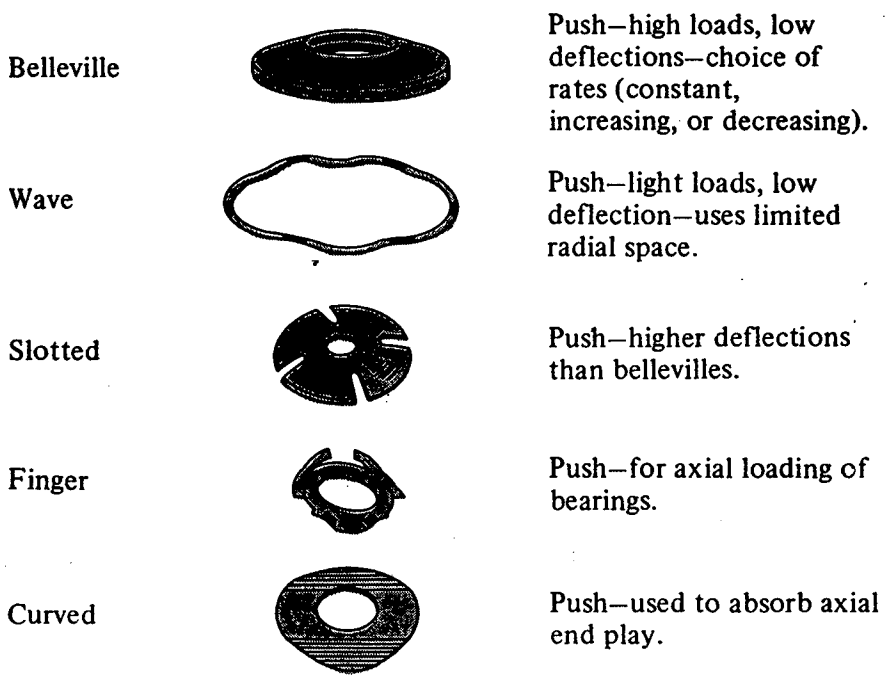

(b) Spring washer

FIGURE 18.2
Basic types of springs [82].

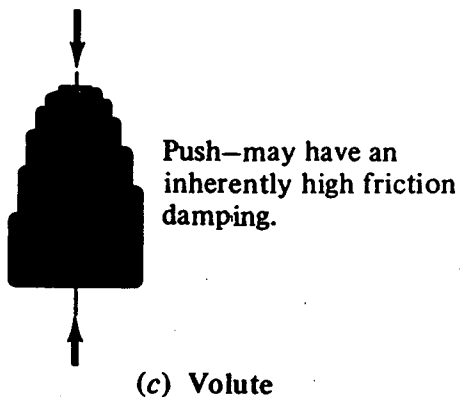

Push—or pull—wide range of loads, low deflection range.



(d) Beam

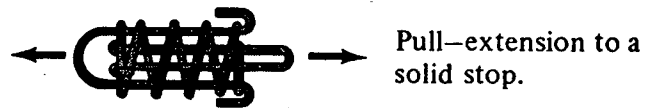
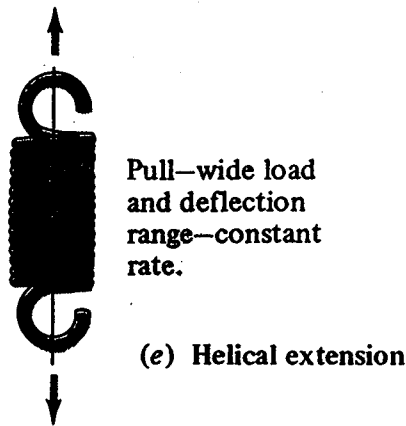

(f) Drawbar

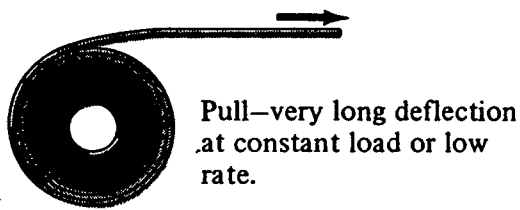

(g) Constant force

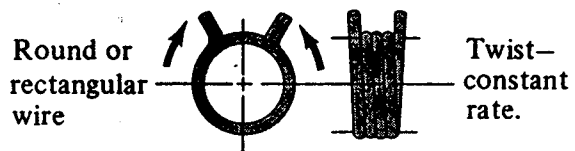

(h) Helical torsion

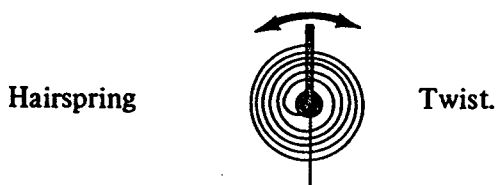

Twist—exerts torque on many turns.
Supplied in retainer.



Removed from retainer.

(i) Spiral

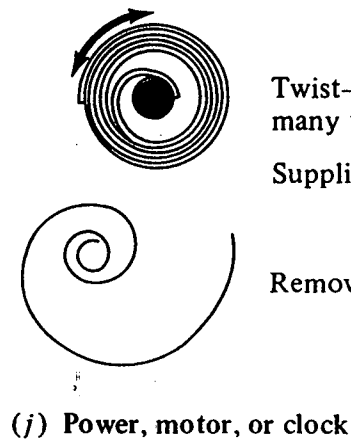



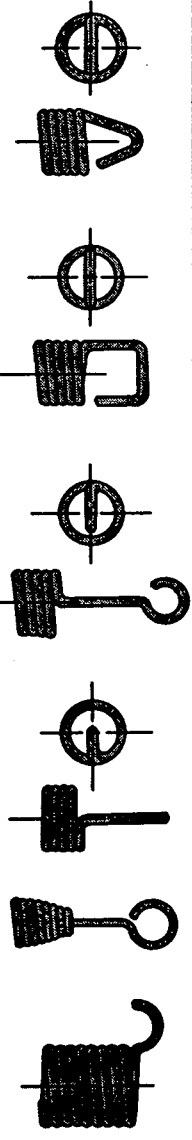

FIGURE 18.2 (Continued)

Type	Configurations	Recommended length* minimum-maximum
Twist loop or hook		0.5-1.7 ID
Cross-center loop or hook		ID
Side loop or hook		0.9-1.0 ID
Extended hook		1.1 ID and up, as required by design
Special ends		As required by design

*Length is distance from last body coil to inside of end. ID is inside diameter of adjacent coil in spring body.

FIGURE 18.12
Common end configurations for helical extension springs [82].

TABLE A-25

Decimal Equivalents of Wire and Sheet-Metal Gauges*
(All Sizes Are Given in Inches)

NAME OF GAUGE:	AMERICAN OR BROWN & SHARPE	BIRMINGHAM OR STUBS IRON WIRE	UNITED STATES STANDARD†	MANUFACTURERS STANDARD	STEEL WIRE OR WASHBURN & MOEN	MUSIC WIRE	STUBS STEEL WIRE	TWIST DRILL
PRINCIPAL USE:	NONFERROUS SHEET, WIRE, AND ROD	TUBING, FERROUS STRIP, FLAT WIRE, AND SPRING STEEL	FERROUS SHEET AND PLATE, 480 lb/ft ³	FERROUS SHEET	FERROUS WIRE EXCEPT MUSIC WIRE	MUSIC WIRE	STEEL DRILL ROD	TWIST DRILLS AND DRILL STEEL
7/0	—	—	0.500	—	0.490 0	—	—	—
6/0	0.580 0	—	0.468 75	—	0.461 5	0.004	—	—
5/0	0.516 5	—	0.437 5	—	0.430 5	0.005	—	—
4/0	0.460 0	0.454	0.406 25	—	0.393 8	0.006	—	—
3/0	0.409 6	0.425	0.375	—	0.362 5	0.007	—	—
2/0	0.364 8	0.380	0.343 75	—	0.331 0	0.008	—	—
0	0.324 9	0.340	0.312 5	—	0.306 5	0.009	—	—
1	0.289 3	0.300	0.281 25	—	0.283 0	0.010	0.227	0.228 0
2	0.257 6	0.284	0.265 625	—	0.262 5	0.011	0.219	0.221 0
3	0.229 4	0.259	0.25	0.239 1	0.243 7	0.012	0.212	0.213 0
4	0.204 3	0.238	0.234 375	0.224 2	0.225 3	0.013	0.207	0.209 0
5	0.181 9	0.220	0.218 75	0.209 2	0.207 0	0.014	0.204	0.205 5
6	0.162 0	0.203	0.203 125	0.194 3	0.192 0	0.016	0.201	0.204 0
7	0.144 3	0.180	0.187 5	0.179 3	0.177 0	0.018	0.199	0.201 0
8	0.128 5	0.165	0.171 875	0.164 4	0.162 0	0.020	0.197	0.199 0
9	0.114 4	0.148	0.156 25	0.149 5	0.148 3	0.022	0.194	0.196 0
10	0.101 9	0.134	0.140 625	0.134 5	0.135 0	0.024	0.191	0.193 5
11	0.090 74	0.120	0.125	0.119 6	0.120 5	0.026	0.188	0.191 0
12	0.080 81	0.109	0.109 357	0.104 6	0.105 5	0.029	0.185	0.189 0
13	0.071 96	0.095	0.093 75	0.089 7	0.091 5	0.031	0.182	0.185 0
14	0.064 08	0.083	0.078 125	0.074 7	0.080 0	0.033	0.180	0.182 0
15	0.057 07	0.072	0.070 312 5	0.067 3	0.072 0	0.035	0.178	0.180 0
16	0.050 82	0.065	0.062 5	0.059 8	0.062 5	0.037	0.175	0.177 0
17	0.045 26	0.058	0.056 25	0.053 8	0.054 0	0.039	0.172	0.173 0
18	0.040 30	0.049	0.05	0.047 8	0.047 5	0.041	0.168	0.169 5
19	0.035 89	0.042	0.043 75	0.041 8	0.041 0	0.043	0.164	0.166 0
20	0.031 96	0.035	0.037 5	0.035 9	0.034 8	0.045	0.161	0.161 0
21	0.028 46	0.032	0.034 375	0.032 9	0.031 7	0.047	0.157	0.159 0
22	0.025 35	0.028	0.031 25	0.029 9	0.028 6	0.049	0.155	0.157 0
23	0.022 57	0.025	0.028 125	0.026 9	0.025 8	0.051	0.153	0.154 0
24	0.020 10	0.022	0.025	0.023 9	0.023 0	0.055	0.151	0.152 0
25	0.017 90	0.020	0.021 875	0.020 9	0.020 4	0.059	0.148	0.149 5
26	0.015 94	0.018	0.018 75	0.017 9	0.018 1	0.063	0.146	0.147 0
27	0.014 20	0.016	0.017 187 5	0.016 4	0.017 3	0.067	0.143	0.144 0
28	0.012 64	0.014	0.015 625	0.014 9	0.016 2	0.071	0.139	0.140 5
29	0.011 26	0.013	0.014 062 5	0.013 5	0.015 0	0.075	0.134	0.136 0
30	0.010 03	0.012	0.012 5	0.012 0	0.014 0	0.080	0.127	0.128 5
31	0.008 928	0.010	0.010 937 5	0.010 5	0.013 2	0.085	0.120	0.120 0
32	0.007 950	0.009	0.010 156 25	0.009 7	0.012 8	0.090	0.115	0.116 0
33	0.007 080	0.008	0.009 375	0.009 0	0.011 8	0.095	0.112	0.113 0
34	0.006 305	0.007	0.008 593 75	0.008 2	0.010 4	—	0.110	0.111 0
35	0.005 615	0.005	0.007 812 5	0.007 5	0.009 5	—	0.108	0.110 0
36	0.005 000	0.004	0.007 031 25	0.006 7	0.009 0	—	0.106	0.106 5
37	0.004 453	—	0.006 640 625	0.006 4	0.008 5	—	0.103	0.104 0
38	0.003 965	—	0.006 25	0.006 0	0.008 0	—	0.101	0.101 5
39	0.003 531	—	—	—	0.007 5	—	0.099	0.099 5
40	0.003 145	—	—	—	0.007 0	—	0.097	0.098 0

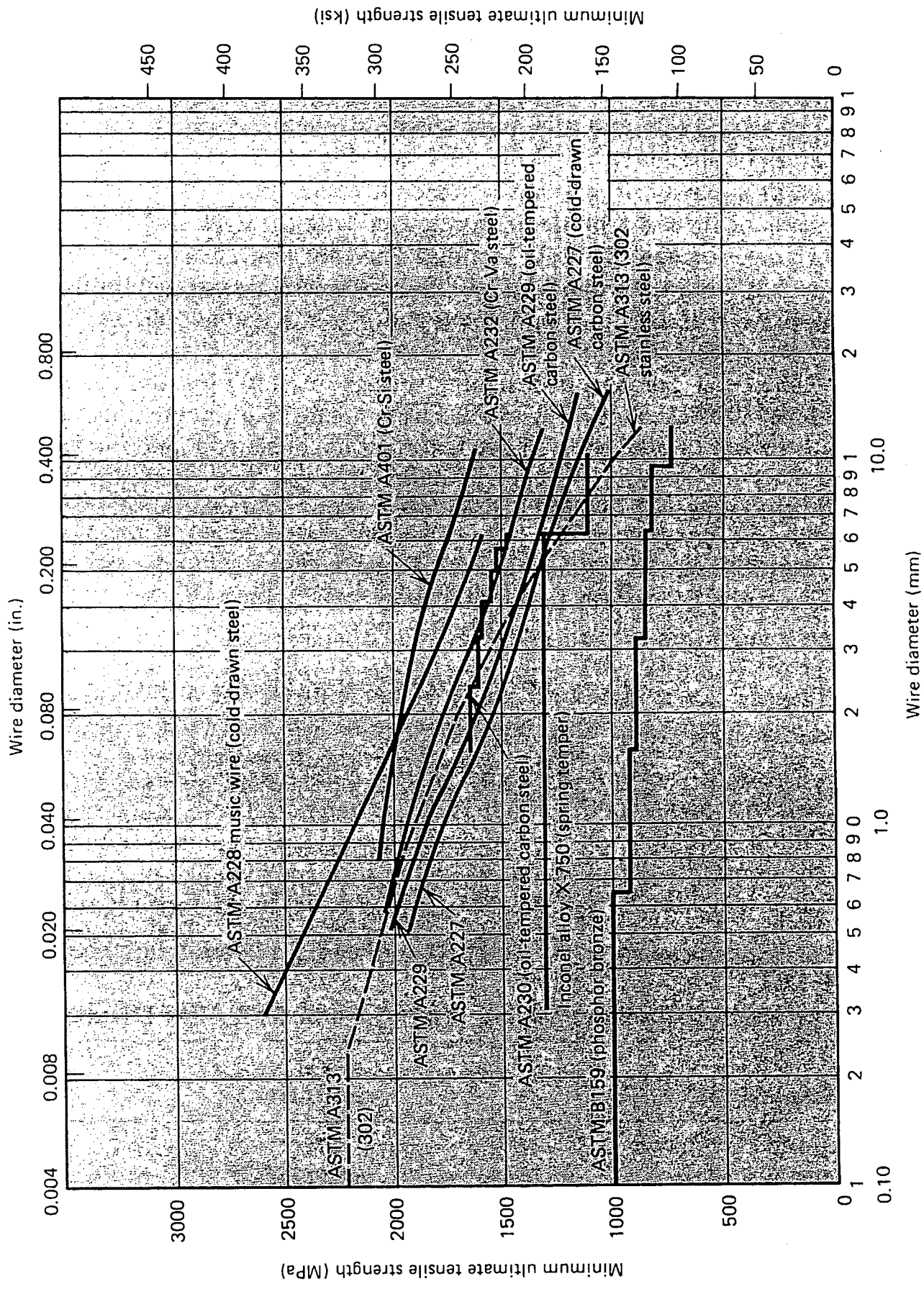

Figure 12.7 Tensile strengths of various spring wire materials and diameters, minimum values [2].